

# 内容详见附页

说明： * V1 * 骑马钉装订 * 尺寸：410(L)x288(W)mm * 材料：80g书写纸，双面印刷 * 颜色及其它详见电子文档 * 请送样品确认。	作废	_____
	作废	_____
	作废	_____
	作废	_____
	作废	_____

日期	2019-09-24	名称	美国KAT KT-200贴DM-4S说明书		料号	09601-14002-00110		版本	V1
制图	郑敬轩	文件名	美国KAT KT-200贴DM-4S说明书.cdr		光盘号	_____		材料	80g书写纸
内容审核		视角	_____	单位	毫米(mm)	颜色		图号	
标准化		 深圳市蔚科电子科技有限公司 CHERUB TECHNOLOGY COMPANY LIMITED				尺寸公差	±1.5mm	密级	普通
批准	郑敬轩					第(1)页/共(15)页			

**User Manual**

**KAT**

**KT-200  
DIGITAL DRUM KIT**

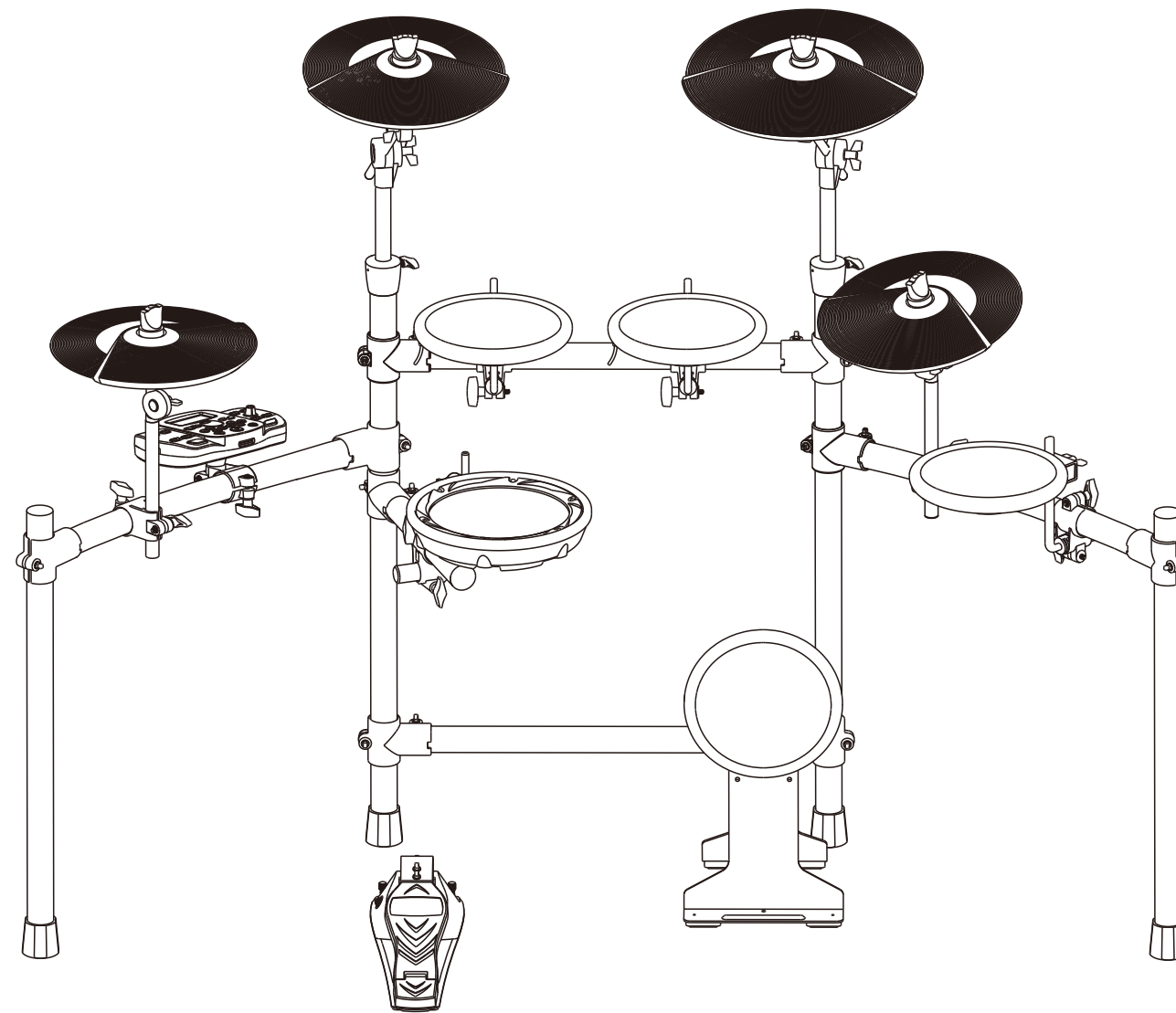

## USING THE UNIT SAFELY

### INSTRUCTIONS FOR THE PREVENTION OF FIRE, ELECTRIC SHOCK, OR INJURY TO PERSONS

#### About **⚠ WARNING** and **⚠ CAUTION** Notices About the Symbol

<b>⚠ WARNING</b>	Used for instructions intended to alert the user to the risk of death or severe injury should the unit be used improperly.	<b>⚠ CAUTION</b>	Used for instructions intended to alert the user to the risk of injury or material damage should the unit be used improperly. * Material damage refers to damage or other adverse effects caused with respect to the home and all its furnishings, as well to domestic animals or pets.
------------------	--	------------------	--

### ALWAYS OBSERVE THE FOLLOWING

#### **⚠ WARNING**

- Before using this unit, make sure to read the instructions below and the Owner's Manual.
- Do not open (or modify in any way) the unit or its AC adaptor.
- Do not attempt to repair the unit, or replace parts within it (except when this manual provides specific instructions directing you to do so). Refer all servicing to your retailer, the nearest Service Center.
- Never use or store the unit in places that are:
  - Subject to temperature extremes (e.g., direct sunlight in an enclosed vehicle, near a heating duct, on top of heat-generating equipment); or are
  - Damp (e.g., baths, washrooms, on wet floors); or Are
  - Humid; or Are
  - Exposed to rain; or Are
  - Dusty; or Are
  - Subject to high levels of vibration.
- This unit may be installed on a stand using a Clamp.
- When installing the unit on a stand with a clamp, the stand must not be placed in an unstable location or on an incline, but in a level and stable position. Even if a stand is not used, make sure that the unit is placed in a stable location.

#### **⚠ WARNING**

- Be sure to use only the AC adaptor supplied with the unit. Also, make sure the line voltage at the installation matches the input voltage specified on the AC adaptor's body. Other AC adaptors may use a different polarity, or be designed for a different voltage, so their use could result in damage, malfunction, or electric shock.
- Do not excessively twist or bend the power cord, nor place heavy objects on it. Doing so can damage the cord, producing severed elements and short circuits. Damaged cords are fire and shock Hazards!
- This unit, either alone or in combination with an amplifier and headphones or speakers, may be capable of producing sound levels that could cause permanent hearing loss. Do not operate for a long period of time at a high volume level, or at a level that is uncomfortable. If you experience any hearing loss or ringing in the ears, you should immediately stop using the unit, and consult an Audiologist.
- Do not allow any objects (e.g., flammable material, coins, pins); or liquids of any kind (water, soft drinks, etc.) to penetrate the unit.

#### **⚠ WARNING**

- Immediately turn the power off, remove the AC adaptor from the outlet, and request servicing by your retailer, the nearest Service Center.
- The AC adaptor or the power-supply cord has been damaged; or
- If smoke or an unusual odor occurs
- Objects have fallen into, or liquid has been spilled onto the unit; or
- The unit has been exposed to rain (or otherwise has become wet); or
- The unit does not appear to operate normally or exhibits a marked change in performance.

- In households with small children, an adult should provide supervision until the child is capable of following all the rules essential for the safe operation of the unit.

- Protect the unit from strong impact. (Do not drop it!)

- Do not force the unit's power-supply cord to share an outlet with an unreasonable number of other devices. Be especially careful when using extension cords—the total power used by all devices you have connected to the extension cord's outlet must never exceed the power rating (watts/amperes) for the extension cord. Excessive loads can cause the insulation on the cord to heat up and eventually melt through.

- Before using the unit in a foreign country, consult with your retailer, the nearest Service Center.

#### **⚠ CAUTION**

- The unit and the AC adaptor should be located so their location or position does not interfere with their proper ventilation.
- Always grasp only the output plug or the body of the AC adaptor when plugging into, or unplugging from, this unit or an outlet.
- Any accumulation of dust between the AC adaptor and the power outlet can result in poor insulation and lead to fire. Periodically wipe away such dust with a dry cloth. Also, disconnect the power plug from the power outlet whenever the unit is to remain unused for an extended period of time.
- Try to prevent cords and cables from becoming entangled. Also, all cords and cables should be placed so they are out of the reach of children.
- Never climb on top of, nor place heavy objects on the unit.
- Never handle the AC adaptor body, or its output plugs, with wet hands when plugging into, or unplugging from, an outlet or this unit.
- If you need to move the instrument, take note of the precautions listed below. Make sure to have a firm grip, to protect yourself from injury and the instrument from damage.
  - Check to make sure that the clamp that fixes the unit to the stand has not become loose. Fasten them again securely whenever you notice any loosening.
  - Disconnect the power cord.
  - Disconnect all cords coming from external devices.
- Before cleaning the unit, turn off the power and unplug the AC adaptor from the outlet.
- Whenever you suspect the possibility of lightning in your area, disconnect the AC adaptor from the outlet.
- Should you remove security screws, make sure to put them in a safe place out of children's reach, so there is no chance of them being swallowed accidentally.

# CONTENTS

<b>Panel and Interface</b> .....	4
Top Panel .....	4
Front Panel .....	5
<b>Mounting and Connection</b> .....	6
Connection .....	6
Mounting the KT-200 on the Stand .....	7
Screen Display .....	8
<b>Ready to play</b> .....	9
Turning ON/OFF the Power .....	9
Performance Techniques .....	10
<b>Drum Kit Operation</b> .....	12
Selecting a Drum Kit .....	12
Setting the Drum Kit .....	12
Pad Settings .....	13
Setting Effects in a Drum Kit .....	14
Naming a Drum Kit .....	15
Saving a Drum Kit .....	15
<b>DEMO Function</b> .....	16
Song setting .....	16
<b>Metronome Function</b> .....	17
<b>Recording and Playback Function</b> .....	18
<b>Coach Function</b> .....	19
<b>System Settings</b> .....	21
Pad settings .....	21
Restoring the Factory Settings .....	23
Basic Settings .....	23
USB-MIDI Function .....	24
<b>Specifications</b> .....	24
<b>MIDI Implementation Char</b> .....	25
<b>Drum Kit Preset Name</b> .....	26

# PANEL AND INTERFACE

## Top Panel

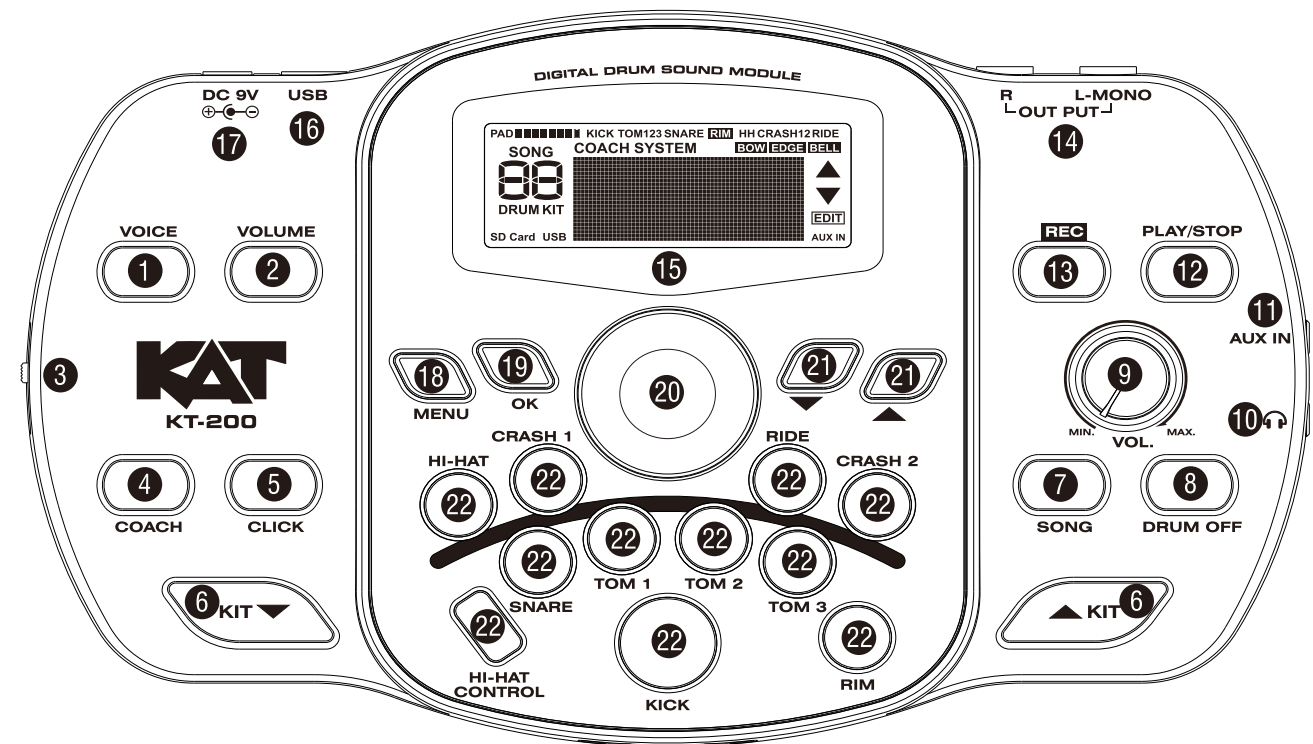

- |   |  |
|---|--|
| <p><b>1. VOICE Button</b><br/>Press <b>VOICE</b> button to adjust the pad's voice.</p> <p><b>2. VOLUME Button</b><br/>Press <b>VOLUME</b> button to adjust the pad's volume.</p> <p><b>3. POWER Switch</b><br/>Turn on/off the power</p> <p><b>4. COACH Button</b><br/>Press <b>COACH</b> button to enter coach function.</p> <p><b>5. CLICK Button</b><br/>Turn on/off the metronome.</p> <p><b>6. KIT▲▼ Buttons</b><br/>Press ▲▼ to switch drum kits.</p> <p><b>7. SONG Button</b><br/>Select demo songs.</p> <p><b>8. DRUM OFF Button</b><br/>Mute the drum part from demo song.</p> <p><b>9. VOLUME Knob</b><br/>Adjust the volume of the OUTPUT and HEADPHONE jacks.</p> | <p><b>10. HEADPHONE Jack</b></p> <p><b>11. AUX IN Jack</b><br/>For connecting an external audio source such as MP3 or CD player. All sound input here will be sent to the OUTPUT and HEADPHONE jacks.</p> <p><b>12. PLAY Button</b><br/>Play what you recorded, and the demo songs.</p> <p><b>13. REC Button</b><br/>Press <b>REC</b> button to record your playing.</p> <p><b>14. OUTPUT Jack (L/MONO, R)</b><br/>These are the main stereo outputs. If you only output mono signal, use only the <b>L/MONO</b> jack.</p> <p><b>15. LCD Display</b><br/>This shows the drum kit name, song's name and other information. During editing, this shows the contents of the settings.</p> <p><b>16. USB Port</b></p> <p><b>17. DC IN Jack</b><br/>Connect the 9V DC adaptor here.</p> |
|---|--|

**18.MENU Button.**

Press **MENU** button to enter the main menu.

**19.OK Button**

Use this to confirm a value you've edited.

**20.VALUE Knob**

Adjust the parameter you are editing.

**21. ▲ and ▼ Buttons**

Choose the menu item you want to edit.

**22.Drum Pad Buttons**

Press the drum pad button to choose it and make a corresponding sound.

**Front Panel**

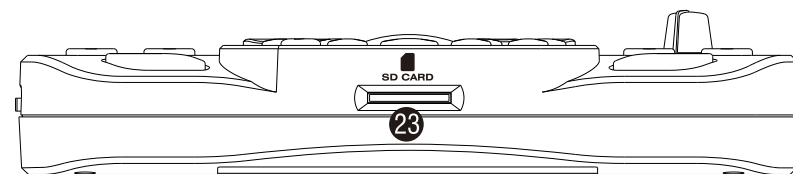

**23.SD Card Slot**

For MIDI song playing through SD card.

**CONNECTION**

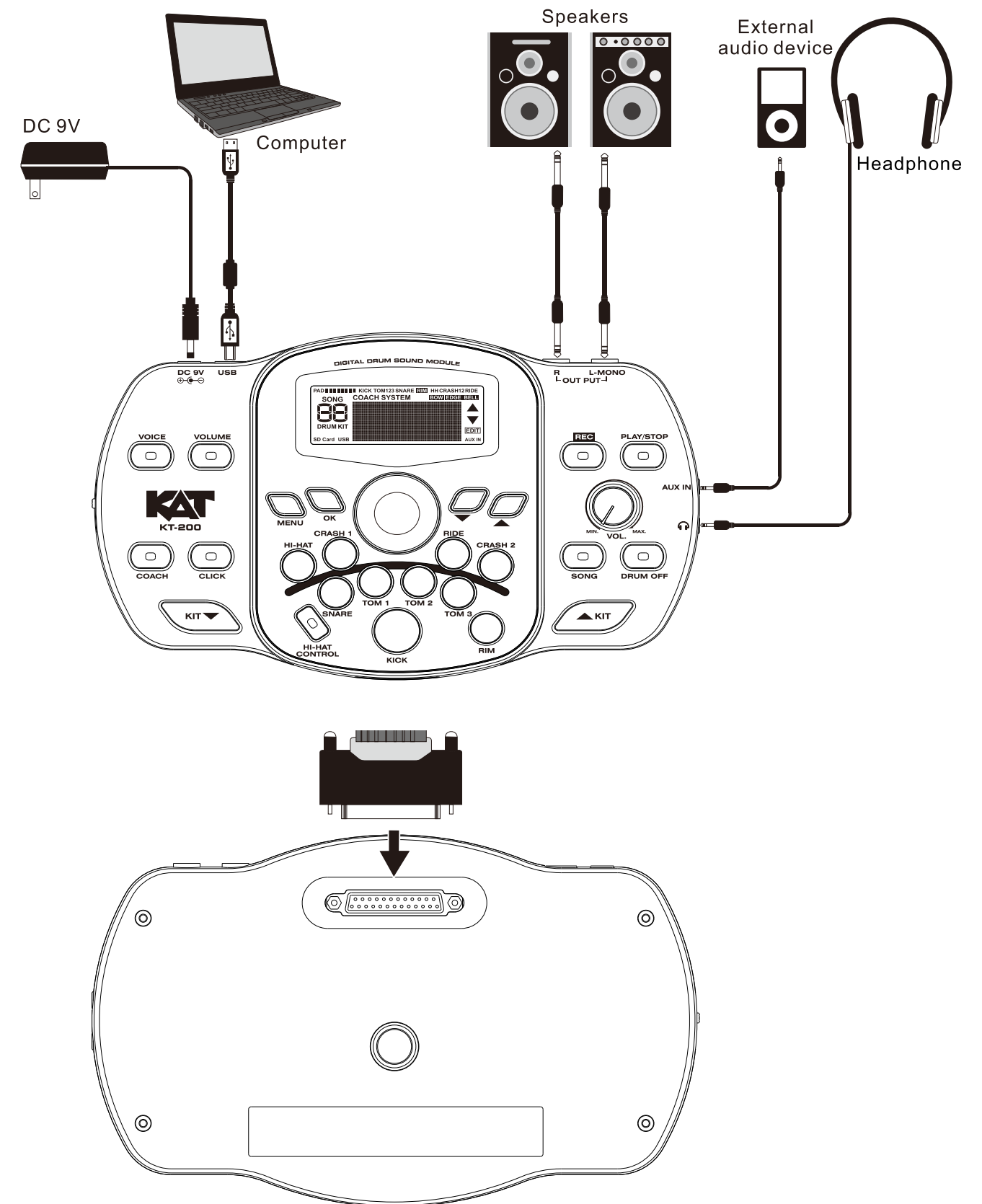

**NOTE:**

To prevent malfunction and/or damage to speakers or other devices, always turn down the volume, and turn off the power on all devices before making connections.

## MOUNTING THE KT-200 ON THE STAND

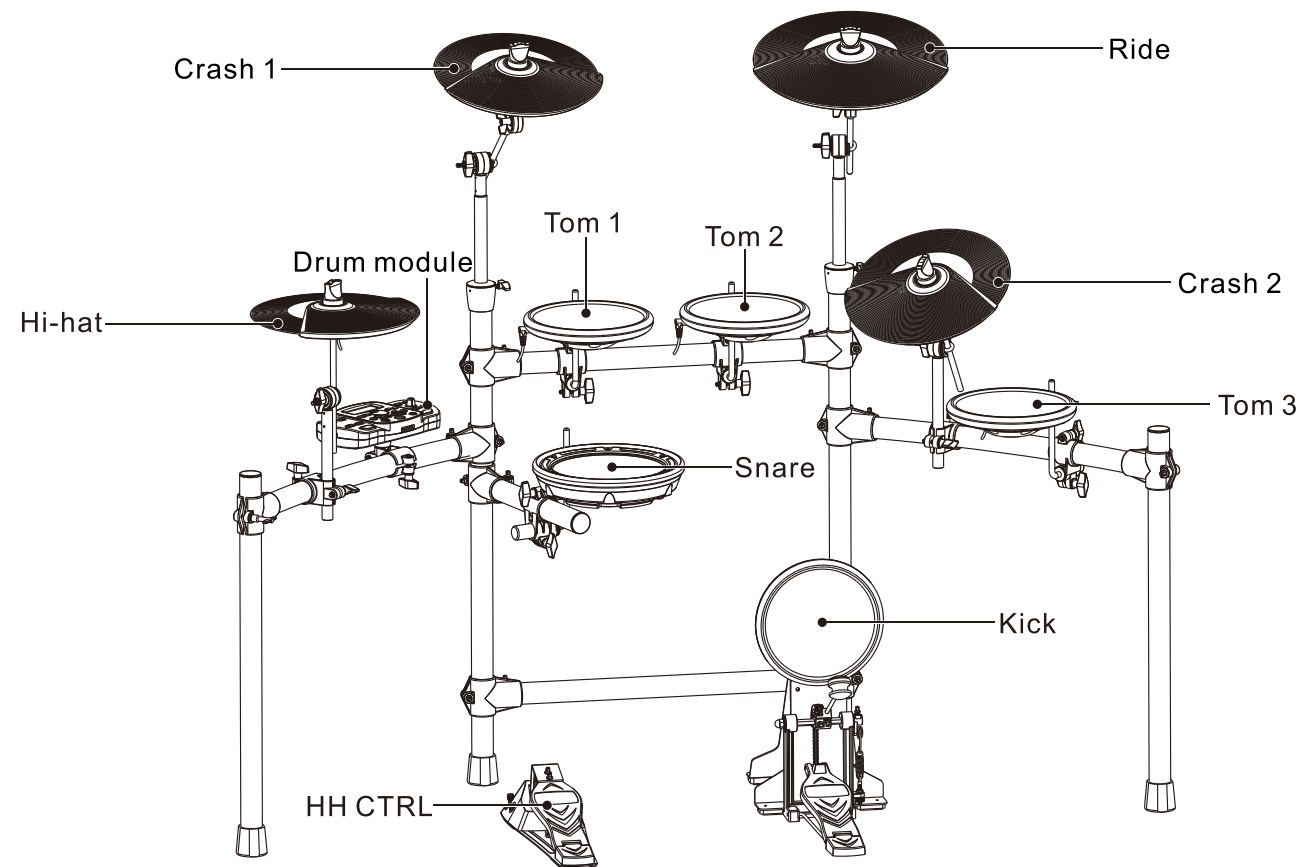

1. Attach the included sound module mounting plate to the KT-200. Use included wing bolts to attach the plate as shown in the illustration.

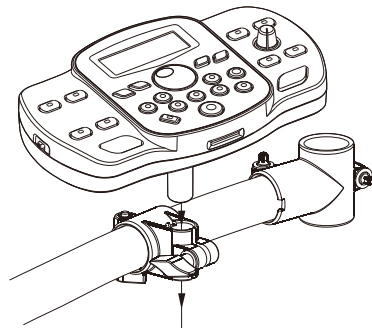

2. Attach the KT-200 (with the sound module mounting plate installed) to your drum stand.

3. Connect the included cable to the KT-200 TRIGGER IN connector, and connect your pads and pedals.

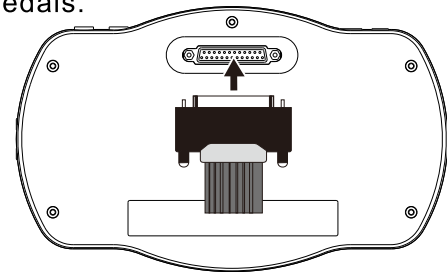

Labels indicating the pad to be connected are attached to the cable.

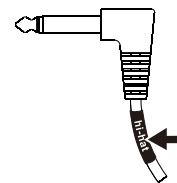

Connect the pads and pedals as shown in the illustration.

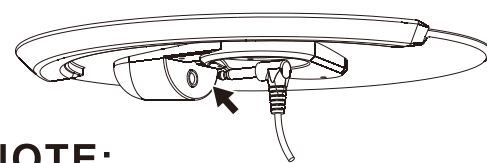
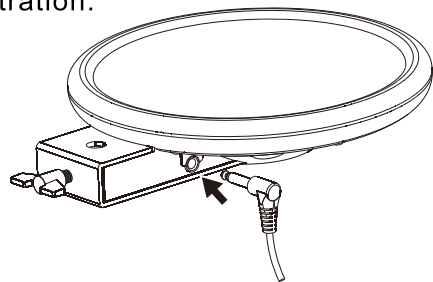

**NOTE:**  
To protect device, when connect to device, please power off.

## SCREEN DISPLAY

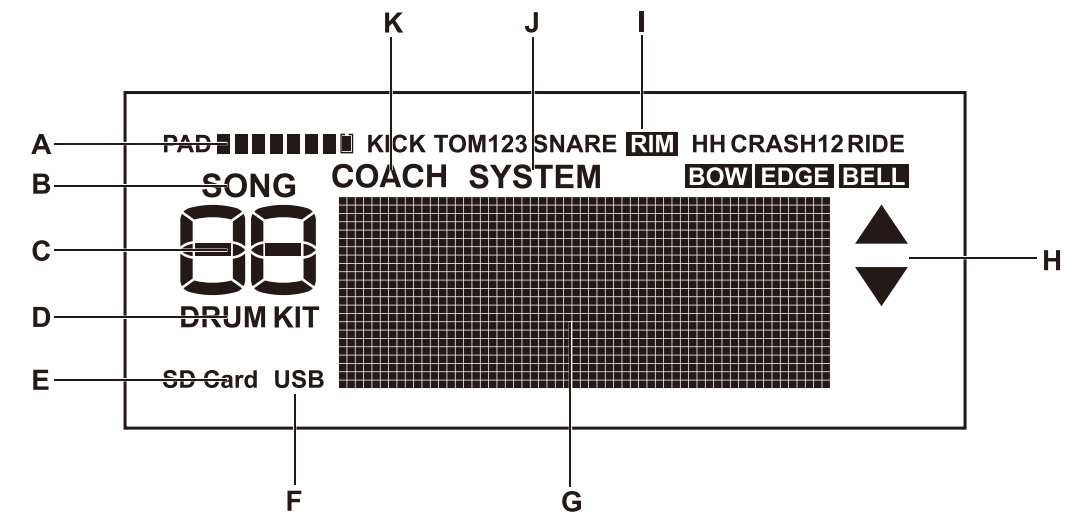

- A. Strength of the pad strike displayed in 8 levels.
- B. SONG indicator
- C. Drum kit number or SONG number
- D. Drum kit indicator
- E. SD card indicator

- F. USB connection indicator
- G. Dot matrix area
- H. ▲ and ▼ indicator
- I. Pad name display
- J. SYSTEM setting indicator
- K. COACH function indicator

# READY TO PLAY

## Turn ON/OFF the Power

### \* Turn on the power

1. Turn the VOL knob to the minimum.
2. Adjust the volume of the connected amp or audio system to the minimum.
3. Turn the power switch to ON.

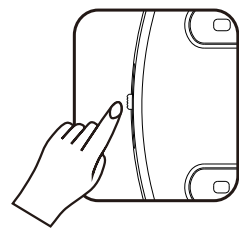

### \* Turn off the power

1. Turn the volume of KT-200 and external equipments to the minimum.
2. Power off the external equipment.
3. Turn the power switch to OFF.

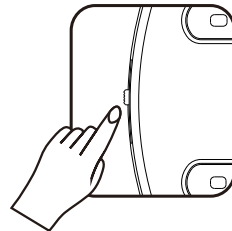

Welcome to  
YOUR-DRUM

\* You may still hear some sound when the power is switched on, this is normal, and does not indicate a malfunction.

After power on, LCD will display drum kit number and name.



**NOTE:** Preset indicate preset Drum Kit;  
User indicate user Drum kit

4. Power on the external amp or audio system.
5. While hitting a pad, gradually turn the VOL knob toward the right to adjust the volume.

## Performance Techniques

### \* Snare

#### Head Shot

Hit only the head of the pad.

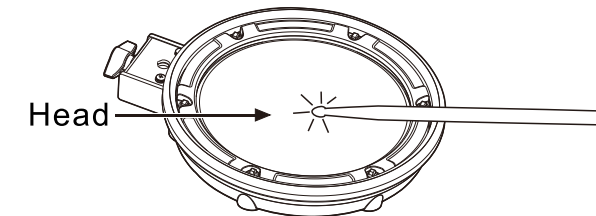

#### Open Rim Shot

Strike the rim of the pad.

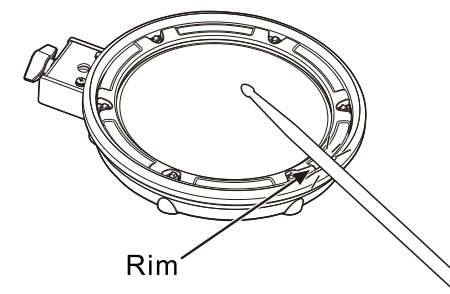

### \* Tom

#### Head Shot

Hit only the head of the pad.

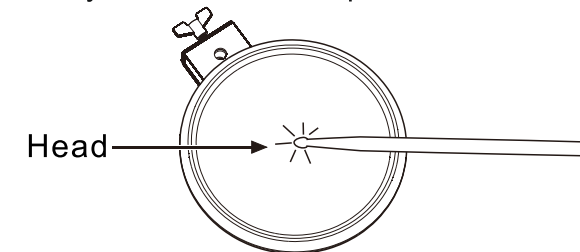

### \* Kick

#### Head Shot

Hit only the head of the pad.

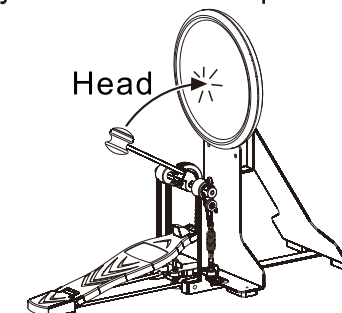

### \* Cymbals (Crash Ride)

#### Bow Shot

Playing the middle area of the cymbal.

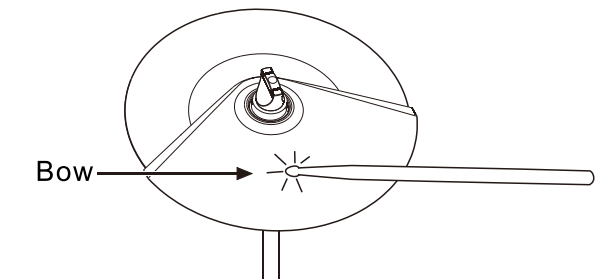

#### Edge Shot

When striking the edge with the shoulder of the stick.

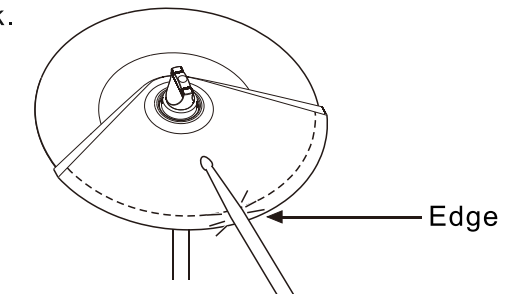

#### Choking a Cymbal

Choking the cymbal's edge with the hand immediately after hitting the cymbal will mute or choke the sound, just like with a real cymbal. The Choke function only works when you grasp in the area.

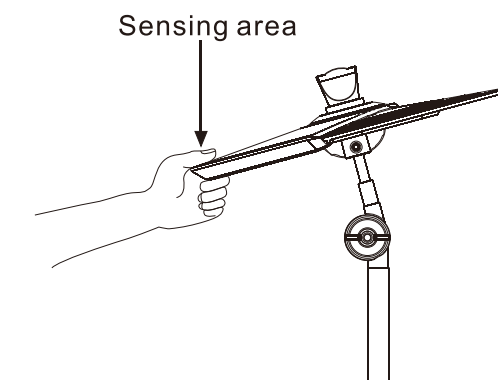

### \* Hi-Hat

#### Open/Closed

The hi-hat sound will change smoothly between open and closed depending on pressure applied to the hi-hat control pedal. Foot closed and foot splash sounds are possible.

### Bow Shot

Hit the middle area of the hi-hat pad.

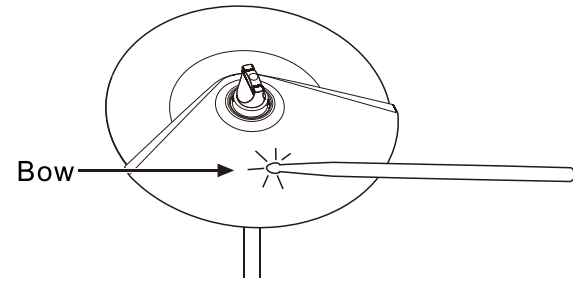

### Choke a Cymbal

Choke the cymbal's edge with the hand immediately after hitting the cymbal will mute or choke the sound, just like with a real cymbal. The choke function only works when you grasp in the area.

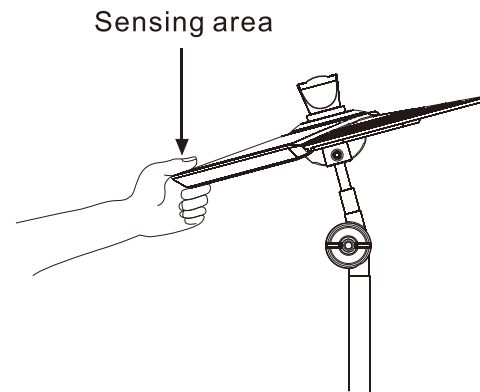

### \*Hi-Hat Control Pedal

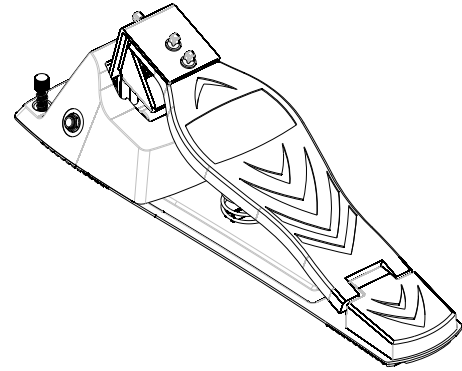

#### Open Hi-Hat

Strike the hi-hat without pressing the pedal.

#### Closed Hi-Hat

Strike the hi-hat with the pedal pressed.

## DRUM KIT OPERATION

### Selecting a Drum Kit

When you turn on the KT-200, you are in drum kit mode. A drum kit is a combination of the sounds and settings for each pad and pedal, as well as ambience.



1. Press the KIT▲ and ▼ buttons to select drum kit.

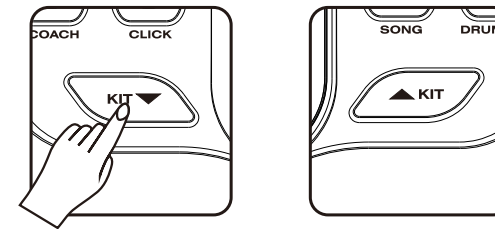

2. Press the KIT▲ and ▼ buttons under any mode will get back to DRUM KIT mode.

### Setting the Drum Kit

1. Use the KIT▲ and ▼ buttons to select the drum kit that you want to edit.
2. Press the MENU button.

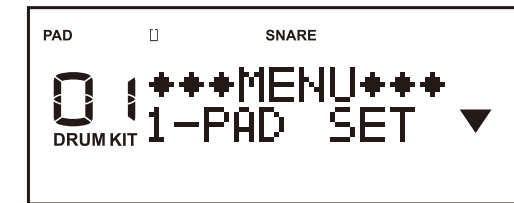

3. Use the ▲ and ▼ buttons to select the desired menu.

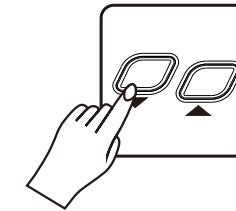

4. Turn the VALUE dial to select the pad which you want to edit. (You also can select the pad through striking the pad you want to edit)

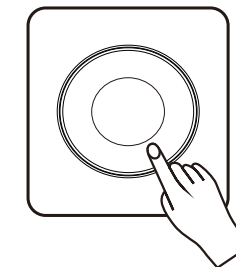

5. When you've selected the desired menu, press the OK button.

**Example: PAD SET MENU**

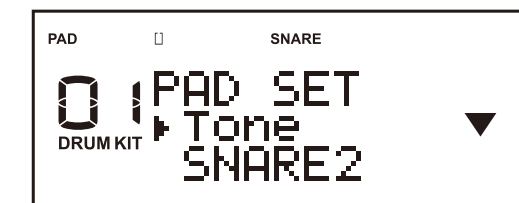

6. When you've finished making settings, press the MENU button; you'll return to the DRUM KIT screen.



## Pad Settings

1. In the menu screen, choose "PAD SET" and press the OK button.

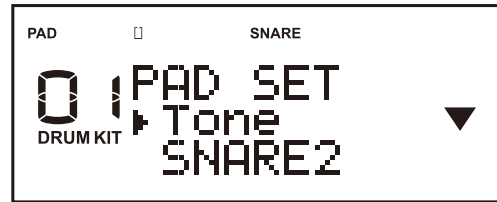

- Use the ▲ and ▼ buttons to select a parameter.
- Strike a pad to select the pad whose settings you want to edit.
- Use the VALUE dial to edit the setting.
- Press the OK button to return to the "MENU" screen.

Screen Display	Parameter	Value	Description
	TONE	SNARE1-SNARE25	Selects instrument type
	VOLUME	0-127	Specifies the instrument volume
	PAN	L64-CENTER-R63	Specifies Instrument pan position
	PITCH	-8—0—+8	Specifies Instrument pitch
	CURVE	LINEAR LOG EXP LOUD	Adjusts the curve of volume change in response to your playing velocity
	REVERB LEVEL	0-127	Specifies the instrument reverb level
	CHORUS LEVEL	0-127	Specifies the instrument chorus level

### LINEAR

The standard setting. This produces the most natural correspondence between playing dynamics and volume change.

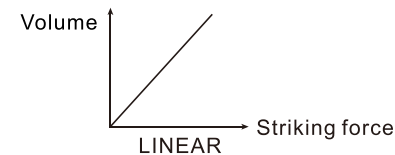

### LOG

Compared to LINEAR, a soft playing produces a greater change.

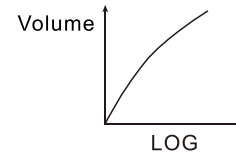

### EXP

Compared to LINEAR, strong dynamics produce a greater change.

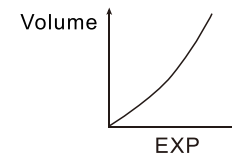

### LOUD

Very little dynamic response, making it easy to maintain strong volume levels. If using drum triggers, these settings help maintain stable levels.

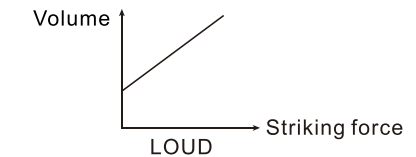

## Setting Effects in a Drum Kit

1. In the menu screen, choose "EFX SET" and press the OK button.



- Use the UP and DOWN buttons to select a parameter.
- Use the VALUE dial to edit the setting.
- Press the OK button to return to the "MENU" screen.

Screen Display	Parameter	Value	Description
	REVERB STYLE	OFF ROOM1 ROOM2 ROOM3 HALL1 HALL2 PLATE DELAY PAN DELAY	Selects reverb type. When selecting OFF, the reverb turn off.
	CHORUS STYLE	OFF CHORUS1 CHORUS2 CHORUS3 CHORUS4 FEEDBACK FLANGER SHORT DELAY FB DELAY	Selects chorus type. When selecting OFF, the chorus turn off.
	EQ SWITCH	ON/OFF	Turns ON/OFF the EQ function.
	EQ-LOW	-12db—+12db	Adjusts the low frequency
	EQ-HIGH	-12db—+12db	Adjusts the high frequency

## Naming a Drum Kit

1. In the menu screen, choose "3-KIT NAME" and press the OK button.

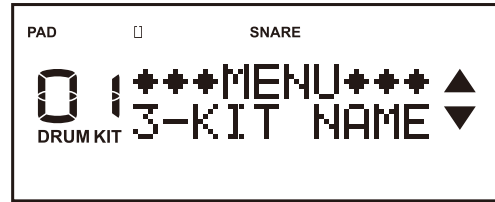

2. Press the UP and DOWN button to move the cursor to the character that you want to edit.
3. Use the VALUE dial to change the letters.



4. Press the OK button to return to the "MENU" screen.

## Saving a Drum Kit

1. In the menu screen, choose "4-KIT SAVE" and press the OK button.

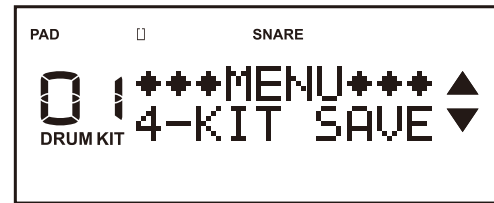

2. Use the VALUE dial to choose the drum kit number.

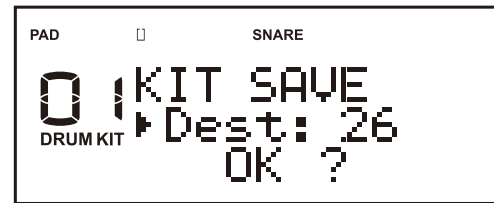

3. Press the OK button to execute the save operation.
4. When operation is completed, you'll be returned to the drum kit screen automatically.

## DEMO FUNCTION

1. In the drum kit mode, press SONG button to enter into the DEMO mode.

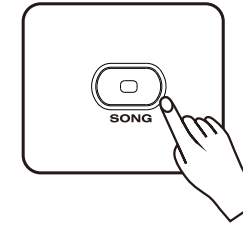

**NOTE:** *Preset indicates DEMO in the device  
User indicates user record.  
SD indicates DEMO in SD card*

2. Use the VALUE dial to choose the demo song you want to play.
3. Press the PLAY button to play the song.
4. You can turn off the drum part of the demo song by pressing the DRUM OFF button.

**NOTE:** *Each demo song has their own tempo.*

## Song setting

1. In the menu screen, choose "6-SONG" and press the OK button.

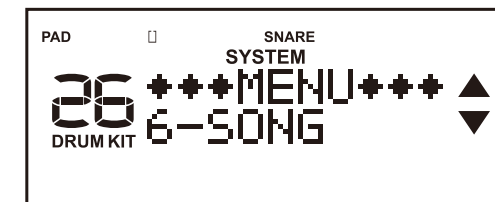

2. Press the UP and DOWN button to select a parameter.
3. Use the VALUE dial to adjust the parameter value.

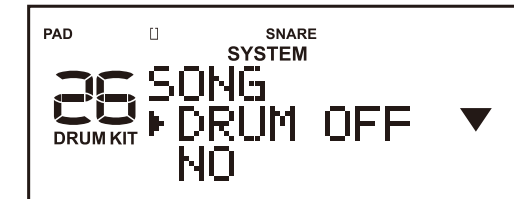

4. Press the OK button to return the MENU.

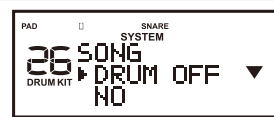
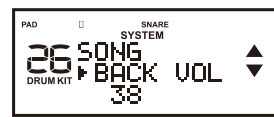
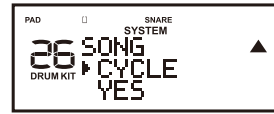
Screen Display	Parameter	Value	Description
	DRUM OFF	NO/YES	Turns ON/OFF the drum part of a song.
	BACK VOLUME	0-127	Adjusts the volume of the backing track.
	CYCLE	NO/YES	Switches on/off loop play.

**NOTE:**

*The parameter will be saved automatically when exiting this mode.  
(except DRUM OFF parameter)*

## METRONOME FUNCTION

Press the CLICK button. The metronome starts and the screen will indicate the tempo.

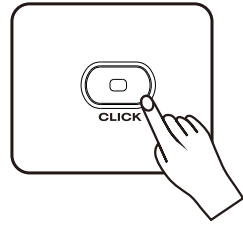

1. In the menu screen, choose "5-CLICK" and press the OK button.

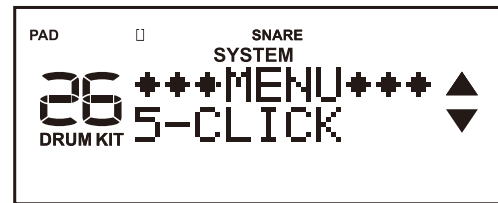





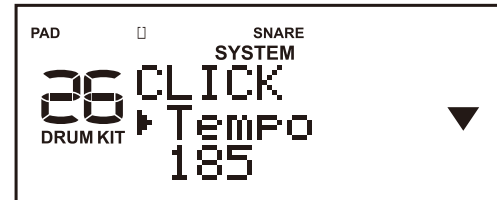

2. Press the UP and DOWN button to select a parameter.

3. Use the VALUE dial to adjust the parameter value.

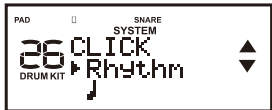

4. Press the OK button to return the MENU.

Screen Display	Parameter	Value	Description
	TEMPO	40-220	Specifies the tempo of the metronome.
	BEAT	1-9	Specifies the time signature of the metronome.
	RHYTHM		Specifies the note value that will be sounded by the metronome.
	VOLUME	0-127	Specifies the volume of the metronome.
	SOUND	ELEC ONE, ELEC TWO	Specifies the sound of the metronome.

**NOTE:** The parameter will be saved automatically when exiting this mode.

## RECORDING AND PLAYBACK FUNCTION

Please first select the drum kit that you want to use for recording.

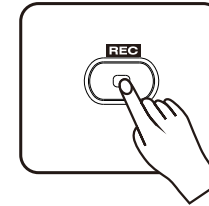

1. Press the REC button, and the KT-200 will enter recording-standby mode.

2. Hit any pad/pedal and recording begins.



### NOTE:

1. when recording, if no drum signal input for more than 4s, it will stop recording and displays COMPLETE!

2. when recording, if memory is full, it will stop recording and display MEMFULL!

3. To stop recording, press the REC button again. If you exceed the maximum recording time, recording stops automatically.

4. Press the PLAY button to PLAYBACK you recorded.

5. When recording, press SONG button to turn on the demo song, so you can record your play with backing track. (when SONG light is lit, it means the demo song is playing while recording at the same time.)

## COACH FUNCTION

1. Under Drum Kit Mode, press COACH button to turn on Coach function.



2. Press Up/Down to select the training function and press OK to enter, or press CLICK button start training.

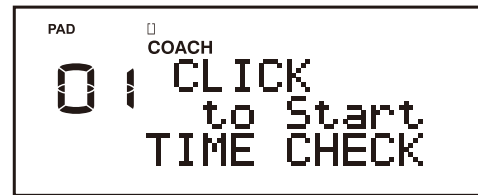

### ●TIME CHECK

You can train your timing under this mode.



- 1) In TIME CHECK mode, press CLICK button to start practicing.

**NOTE:** During practicing, you can change the tempo by turning the VALUE knob.

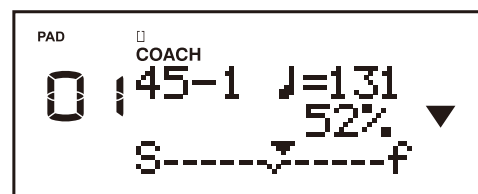

- 2) The LCD shows if your timing matches the metronome. The triangle on the LCD moving towards S means you are slow compared to the metronome; towards F means you are fast. It also shows the percentage of your accuracy.

- 3) In TIME CHECK mode, press MENU button to set parameters.

Use Up/Down buttons to select the parameter item that you want to edit;

Turn the VALUE knob to change the value.



### ●TEMPO CHECK

Under this mode, you can practice in a consistent tempo.



- 1) In TEMPO CHECK mode, press CLICK button to start practicing.

**NOTE:** During practicing, you can change the tempo by turning the VALUE knob.

- 2) Sync the tempo of the pads and the metronome.

**NOTE:** The more accurate you play, the less volume the metronome sounds. The LCD also shows the percentage of your accuracy.

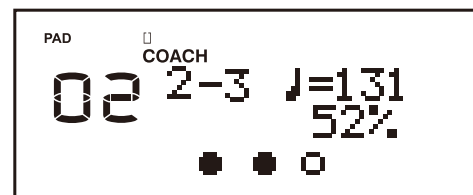

- 3) In TEMPO CHECK mode, press MENU button to set parameters.

Use Up/Down buttons to select the parameter item that you want to edit;

Turn the VALUE knob to change the value.



## COACH FUNCTION

### ●QUIET COUNT

Under this mode, the metronome sound will be alternately on and off for you to train your timing.



- 1) In QUIET COUNT mode, press CLICK to start practicing.

**NOTE:** During practicing, you can change the tempo by turning the VALUE knob.

- 2) The metronome will play for a few bars, and the LCD will display "Ready" at the last bar.

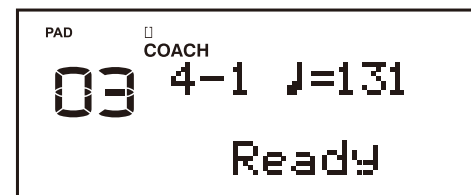

- 3) When the metronome sound is off (metronome still counting internally), the LCD will display "Quiet". You keep playing in accordance to the tempo in your memory.

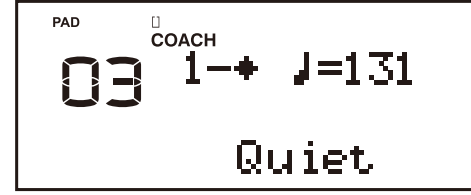

- 4) When the metronome sound comes back again, the LCD will display the accuracy of your playing during the time when the metronome sound was off.

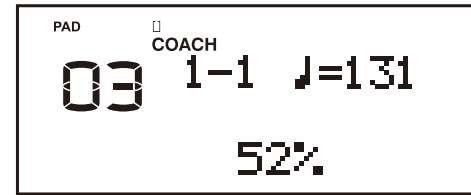

- 5) In QUIET COUNT mode, press MENU button to set parameters.

Use Up/Down buttons to select the parameter item that you want to edit;

Turn the VALUE knob to change the value.



### ●AUTO UPDOWN



- 1) In AUTO UP DOWN mode, press CLICK to start practicing.

**NOTE:** During practicing, you can change the tempo by turning the VALUE knob.

- 2) Sync the tempo of the pads and the metronome.

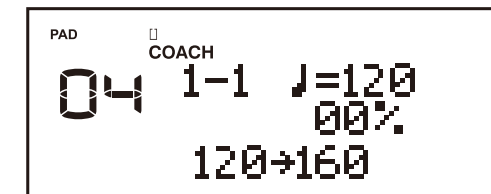

The tempo of the metronome will change between the first tempo and the second tempo. Your accuracy will be displayed on the LCD. It will synchronize with the pads.

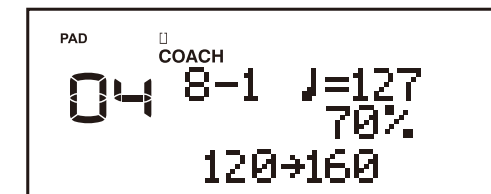

- 3) In QUIET COUNT mode, press MENU button to set parameters.

Use Up/Down buttons to select the parameter item that you want to edit;

Turn the VALUE knob to change the value.

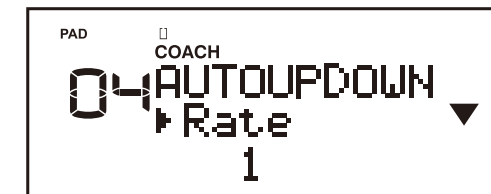

# SYSTEM SETTINGS

## Pad settings

1. In the menu screen, choose "7-TRIGGER" and press the OK button.

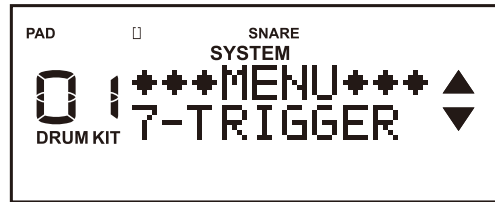

2. Use the VALUE knob to choose the pad you want to edit.
3. Press the UP and DOWN button to select a parameter item.
4. Use the VALUE knob to change the parameter value.
5. Press the OK button to return the MENU.

Screen Display	Parameter	Value	Description
	SENSITIVE	0.1-3.2	You can adjust the sensitivity of the pads to accommodate your personal playing style. Higher sensitivity allows the pad to produce a loud volume even when played softly. Lower sensitivity will keep the pad producing a low volume even when played forcefully.
	THRESHOLD	0-16	This setting allows a trigger signal to be received only when the pad is above a determined dynamic level(velocity). This can be used to prevent a pad from sounding because of vibrations from other pads.

Example: B will sound but A and C will not sound. When set to a higher value, no sound is produced when the pad is struck lightly. Gradually raise the "Threshold" value while striking to pad. Check this and adjust accordingly. Repeat this process until you get the perfect setting for your playing style.

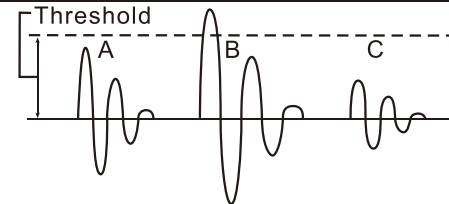

	Scan Time	2ms-8ms	Specifies the detection time for the trigger signal. Since the rise time of the trigger signal waveform may differ slightly depending on the characteristics of each pad or acoustic drum trigger(drum pickup), you may notice that identical hits(velocity) may produce sound at different volumes. If this occurs, you can adjust the "Scan Time" so that your way of playing can be detected more precisely.
--	-----------	---------	---

While repeatedly hitting the pad at a constant force, gradually raise the Scan Time value from 2 ms, until the resulting volume stabilizes at the loudest level. At this setting, try both soft and loud strikes, and make sure that the volume changes appropriately. As the value is set higher, the time it takes for the sound to be played increases. Set this to the lowest value possible.

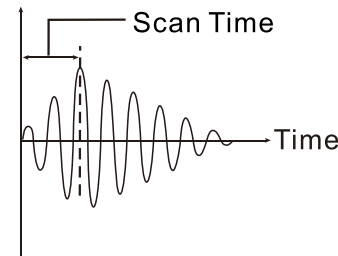

	Mask Time	4ms-64ms	This setting prevents double triggering. When playing a kick trigger, the beater can bounce back and hit the head a second time immediately after the intended note-with acoustic drums sometimes the beater stays against the head-is causes a single hit to "double trigger"). The Mask Time setting helps to prevent this. Once a pad has been hit, any additional trigger signals occurring within the specified 4-64 msec) will be ignored. Adjust the "Mask Time" value while playing the pad.
--	-----------	----------	--

When using a kick trigger, try to let the beater bounce back and hit the head very quickly, then raise the "Mask Time" value until there are no more sounds made by the beater rebound.

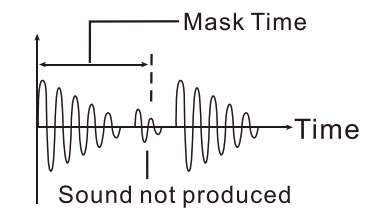

\* When set to a high value, it will be difficult to play very quickly. Set this to as low a value as you can.

	Retrig-cancel	0-16	This setting prevents spurious re-triggering. Important if you are using acoustic drum triggers. Such triggers can produce altered waveforms, which may also cause inadvertent sounding at Point A in the figure (Re-trigger). This occurs in particular at the decaying edge of the waveform. Retrig Cancel detects such distortion in and prevents re-triggering from occurring.
--	---------------	------	--

While repeatedly striking the pad, raise the Retrig Cancel value until re-triggering no longer occurs.

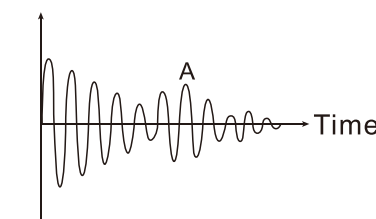

\* Although setting this to a high value prevents retriggering, it then becomes easy for sounds to be omitted when the drums played fast (roll etc.). Set this to the lowest value possible while still ensuring that there is no retriggering.

	X-Talk cancel	0-80%	This setting cancels crosstalk which means that when you play one pad you hear a sound coming from another pad. This can happen when two pads are installed on the same stand. In some cases you can prevent crosstalk by increasing the distance between the two mounted pads.
--	---------------	-------	---

	Rim Gain	0.1-3.2	You can adjust the relation between your playing velocity (force) on the rim/edge and the resulting volume level. Higher value allows the rim/edge to produce a loud volume even when played softly. Lower value will keep the rim/edge producing a low volume even when played forcefully.
--	----------	---------	---

**NOTE:** The parameter will be saved automatically when exiting this mode.

## Restoring the Factory Settings

- In the MENU, choose OPTIONS to enter the setting interface.  
Press ▲▼ key to choose the FAC RESET item, Press OK button to enter the interface of FAC RESET menu.

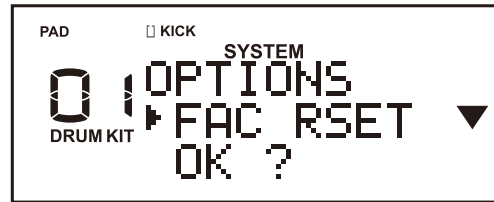

- Press UP and DOWN to choose the options you want to restore:

- Restore the system data such as trigger, song, click etc.

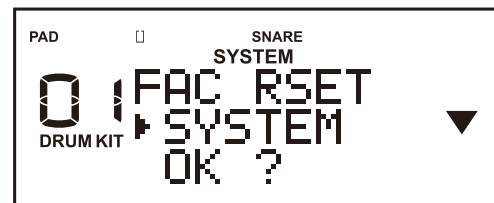

- Restore all data of drum kit.

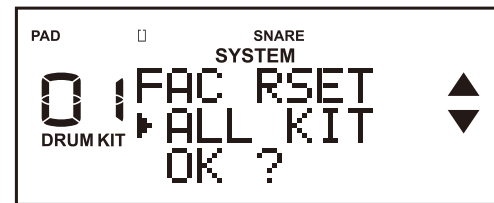

- Restore all data.

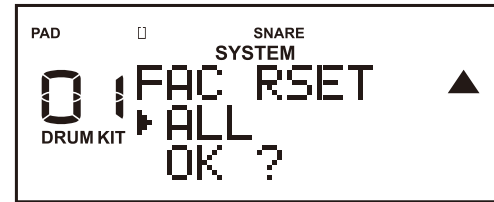

- Press the OK button to return the MENU.

## Basic Settings

- In the MENU choose "9-OPTIONS" and press the OK button.

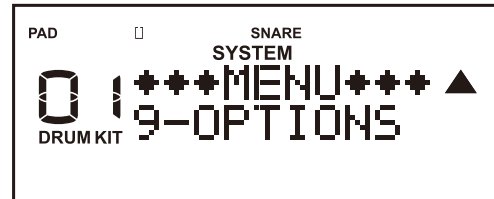

- Press UP and DOWN to choose the options you want to edit.
- Use the VALUE knob to change the parameter value.
- Press the OK button to return the MENU.

屏幕显示	参数名称	调整数值	参数说明
	LCD Contrast	1-10	Adjusts the LCD Contrast.
	Backlight	1-10	Adjusts the LCD brightness.
	Edition	V1.0	Shows firmware edition of the machine.
	Midi channel	1-16	Display the current MIDI channel

## USB-MIDI Function

The KT-200 is equipped with a USB connector. When connected to your computer, the USB ICON will be lit on the LCD and start to transmit the MIDI IN/OUT.

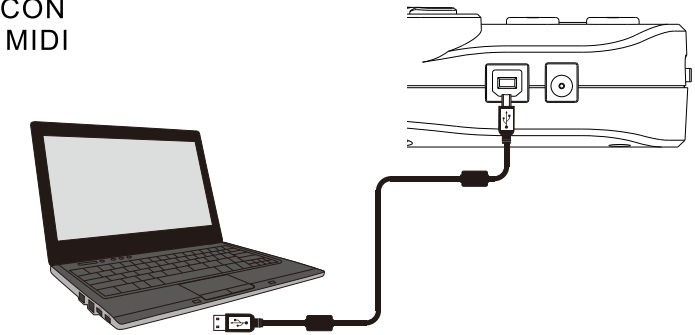

**NOTE:** Before you connect the USB to computer, please close all software about USB-MIDI.

## SPECIFICATIONS

Maximum Polyphony: 64 voices  
 Display: Custom (backlit LCD)  
 Instruments : 232  
 Drum Kits: 50 (User: 25, Factory: 25)  
 Songs: 20  
 Recording: 10  
 Click Sound: Editable (Sound, Tempo, Rhythm Type, Beat, Volume)  
 MIDI Function: USB-MIDI  
 Capacity: SD card (MIDI Playing, MIDI Format 0/Format 1 Supported)  
 Triggers: Tomx3, Snare, Hi-Hat, Crashx2, Ride, Kick  
 Interfaces: Headphones, USB-MIDI, SD card, AUX IN, OUTPUTS  
 Power Supply: DC 9V (⊖ ⊕)

## MIDI Implementation Chart

Function	Transmitted	Recognized	Remarkd
Basic default	10	1-16	
Channel changed	No	No	
Note	0-127	0-127	
Velocity:	Note on	Yes	
	Note off	No	
After Key's	No	Yes	
Touch Channel's	No	Yes	
Control change:	0	No	Bank select
	1	No	Modulation
	5	No	Portamento time
	7	No	Volume
	10	No	Pan
	11	No	Expression
	64	No	Sustain pedal
	65	No	Portamento on/off
	66	No	Sostenuto pedal
	67	No	Soft pedal
	120	No	All sound off
	121	No	Reset all controllers
123	No	All note off	
Program change	No	Yes	Yes
System exclusive	No	No	No

## Drum Kit Preset Name

Number	Name
01	Original
02	Standard
03	Pop
04	Studio
05	Studio1
06	Seesion
07	Metal Mach
08	Metal
09	Speed Metal
10	Hard Rock
11	Dry Rock
12	Classic Dry
13	Funk
14	Funk Tape
15	Modern
16	Nashville
17	Jazz
18	Blues
19	Blues Rock
20	808
21	OpaSid
22	Slam
23	Synthgaze
24	Mirror
25	Folk

### THE FCC REGULATION WARNING (for U.S.A.)

This equipment has been tested and found to comply with the limits for a Class B digital device, pursuant to Part 15 of the FCC Rules. These limits are designed to provide reasonable protection against harmful interference in a residential installation. This equipment generates, uses, and can radiate radio frequency energy and, if not installed and used in accordance with the instructions, may cause harmful interference to radio communications. However, there is no guarantee that interference will not occur in a particular installation. If this equipment does cause harmful interference to radio or television reception, which can be determined by turning the equipment off and on, the user is encouraged to try to correct the interference by one or more of the following measures:

- Reorient or relocate the receiving antenna.
- Increase the separation between the equipment and receiver.
- Connect the equipment into an outlet on a circuit different from that to which the receiver is connected.
- Consult the dealer or an experienced radio/TV technician for help.



Made in China